

**VOLTLIQ**  
PTY



## PROFILE

Volt Lighting manufacture & distribute high end commercial & domestic grade LED lighting, compact fluorescents & metal halide lighting.

With over 16years experience working closely with architects, designers, engineers, shopfitters & electricians to ensure the best possible lighting solutions for our clients needs and budget.

We pride ourselves on providing lighting that is sustainable & energy efficient.

**IGHTING**  
Y LTD

7
1



3

2

**MINILED XDC08**

8W adjustable LED downlight using a single Japanese made COB LED with a high colour rendering index of 90+ and high lumen outputs of 1030Lm (3000K), 1085Lm (4000K) and 1095Lm (5000K). The anodized, pressure cast aluminium heatsink provides efficient thermal dissipation ensuring continued high light output and long lifespan. Available in 2 trim styles covering the popular 76mm and 92mm hole sizes, the 8W Miniled is ideal for use in place of traditional 50W halogen downlights.

4

- LED: 8W / LCP: 10.4W
- COB Lumens: 1085lm / Luminaire Lumens: 845lm
- Lifespan: 50,000 hrs

5

---

7

**Technical Specifications**

	3000K	4000K	5000K
COB Lumen Output	1030 lm	1085 lm	1095 lm
Total Luminous Flux	807 WB	845 WB	851 WB
Efficacy	80.9 lm/W Wide Beam		
Lifetime	50,000hrs (L70)		

Power Factor	> 0.94
Input Voltage	100V - 240V AC 50/60 Hz
Protection	Thermal and Short Circuit
Dimming	Leading / Trailing edge

**Dimensions**

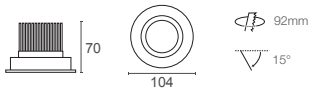

6

**Trim Colours**

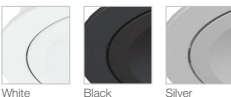

8

---

9

**Order Code**

	Colour Temperature	Beam Angle	Trim Colour	Dimming			
XDC08	3	-	WB	-	B	-	Dim
	3	3000K	WB Wide Beam	W	White Trim	Dim	Leading / Trailing
	4	4000K	NB Narrow Beam	B	Black Trim	DALI	DALI Dimming
	5	5000K		S	Silver Trim	1-10	1-10v Dimming

1 Page Number

2 Product Name and Code

3 Product Image

4 Product Description

5 LED Power Consumption / Total System Power (LCP)

LED Chip lumens / Luminaire Lumens

LED Lifespan

6 Product Dimensions, Adjustment and Cut-Out

Round Cut-Out Angle of Tilt

Square Cut-Out Angle of Rotation





7 Product Technical Specifications

8 Product Colour Options

9 Product Order Codes

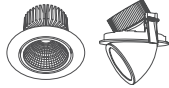
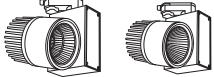
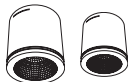

# Contents

	DOWNLIGHTS	8-35
	TRACKLIGHTS	36-41
	SURFACE MOUNTED	42
	WALL WASHERS	43-44
	STRIP	45-46
	PENDANTS	47-49

# Index

MINILED XDA08	6	MINILED XDF26	22	LED SPOT XTS40	38
MINILED XDC08	7	MIDILED XRS	23	LED SPOT XTL40	39
MINILED XDA10	8	MINILED XMB26	24	TRA3C	40
MINILED XDB10	9	MINILED XMB226	25	Track Accessories	41
MINILED XDC10	10	MINILED XMB326	26	SURFACE LED XSM	42
MINILED XDF10	11	MIDILED XDL	27	WALLWASH LED XTW	43
MINILED XDH10	12	MIDILED XDF	28	WALLWASH LED XWW	44
MINILED XDK10	13	MIDILED XDE	29	COVE LED XTP	45
MINILED XDR10	14	MIDILED XMA	30	FLEXILED XF1260	46
MINILED XDT10	15	MIDILED XPF	31	FLEXILED LED DRIVER	46
MINILED XMA10	16	MIDILED XMW	32	MAXIPENDANT XPL48	47
MINILED XMA210	17	MINILED XFS40	33	MAXIPENDANT XPM	48
MINILED XMA310	18	MEGALED XLA	34	MAXIPENDANT XPM80	49
MINILED XDV10	19	MEGALED XLB	35		
MINILED XDS	20	LED SPOT XTS10 & XTS15	36		
MINILED XDM26	21	LED SPOT XTS26	37		

## MINILED XDA08

8W adjustable LED downlight using a single Japanese made COB LED with a high colour rendering index of 90+ and high lumen outputs of 1030lm (3000K), 1085lm (4000K) and 1095lm (5000K). The anodized, pressure cast aluminium heatsink provides efficient thermal dissipation ensuring continued high light output and long lifespan. Available in 2 trim styles covering the popular 76mm and 92mm hole sizes, the 8W Miniled is ideal for use in place of traditional 50W halogen downlights.



-  LED: 8W / LCP: 10.4W
-  COB Lumens: 1085lm / Luminaire Lumens: 845lm
-  Lifespan: 50,000 hrs



### Technical Specifications

	3000K	4000K	5000K
COB Lumen Output	1030 lm	1085 lm	1095 lm
Total Luminous Flux	807 WB	845 WB	851 WB
Efficacy	80.9 lm/W	Wide Beam	
Lifetime	50,000hrs (L70)		
Power Factor	> 0.94		
Input Voltage	100V - 240V AC 50/60 Hz		
Protection	Thermal and Short Circuit		
Dimming	Leading / Trailing edge		

### Dimensions

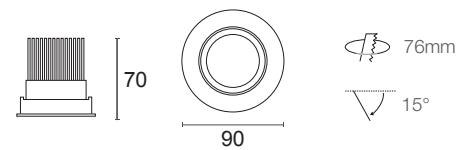

### Trim Colours



### Order Code

	Colour Temperature	Beam Angle	Trim Colour	Dimming				
XDA08	3	-	WB	-	B	-	Dim	
	3	3000K	WB	Wide Beam	W	White Trim	Dim	Leading / Trailing
	4	4000K	NB	Narrow Beam	B	Black Trim	DALI	DALI Dimming
	5	5000K			S	Silver Trim	1-10	1-10v Dimming



## MINILED XDC08

8W adjustable LED downlight using a single Japanese made COB LED with a high colour rendering index of 90+ and high lumen outputs of 1030Lm (3000K), 1085Lm (4000K) and 1095Lm (5000K). The anodized, pressure cast aluminium heatsink provides efficient thermal dissipation ensuring continued high light output and long lifespan. Available in 2 trim styles covering the popular 76mm and 92mm hole sizes, the 8W Miniled is ideal for use in place of traditional 50W halogen downlights.

 LED: 8W / LCP: 10.4W

 COB Lumens: 1085lm / Luminaire Lumens: 845lm

 Lifespan: 50,000 hrs



### Technical Specifications

	3000K	4000K	5000K
COB Lumen Output	1030 lm	1085 lm	1095 lm
Total Luminous Flux	807 WB	845 WB	851 WB
Efficacy	80.9 lm/W	Wide Beam	
Lifetime	50,000hrs (L70)		
Power Factor	> 0.94		
Input Voltage	100V - 240V AC 50/60 Hz		
Protection	Thermal and Short Circuit		
Dimming	Leading / Trailing edge		

### Dimensions

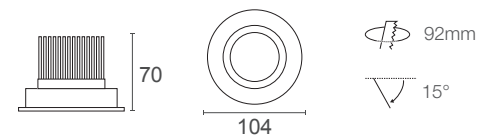

### Trim Colours

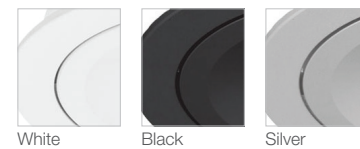



### Order Code

	Colour Temperature	Beam Angle	Trim Colour	Dimming			
XDC08	3	-	WB	-	B	-	Dim
	3 3000K	WB Wide Beam	W White Trim	Dim	Leading / Trailing		
	4 4000K	NB Narrow Beam	B Black Trim	DALI	DALI Dimming		
	5 5000K		S Silver Trim	1-10	1-10v Dimming		

## MINILED XDA10

10 Watt adjustable LED downlight consisting of a single Japanese made COB LED in 3000K, 4000K or 5000K colour temperature options. All colour temperatures have a high colour rendering index (CRI) of 90+ and high lumen outputs of 1335Lm (3000K), 1390Lm (4000K) and 1410Lm (5000K). Large passive heatsink provides effective thermal management ensuring high output and long lifespan.



-  LED: 10.8W / LCP: 13.4W
-  COB Lumens: 1390lm / Luminaire Lumens: 1028lm
-  Lifespan: 50,000 hrs



### Technical Specifications

	3000K	4000K	5000K
COB Lumen Output	1335 lm	1390 lm	1410 lm
Total Luminous Flux	987 WB	1028 WB	1042 WB
Efficacy	79.08 lm/W Wide Beam		
Lifetime	50,000hrs (L70)		
Power Factor	> 0.94		
Input Voltage	100V - 240V AC 50/60 Hz		
Protection	Thermal and Short Circuit		
Dimming	Leading / Trailing edge		

### Dimensions

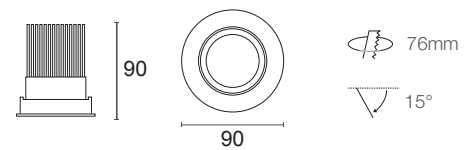

### Trim Colours



### Order Code

	Colour Temperature	Beam Angle	Trim Colour	Dimming			
XDA10	3	-	WB	-	B	-	Dim
	3	3000K	WB Wide Beam	W	White Trim	Dim	Leading / Trailing
	4	4000K	NB Narrow Beam	B	Black Trim	DALI	DALI Dimming
	5	5000K		S	Silver Trim	1-10	1-10v Dimming



### MINILED XDB10

10 Watt adjustable LED downlight consisting of a single Japanese made COB LED in 3000K, 4000K or 5000K colour temperature options. All colour temperatures have a high colour rendering index (CRI) of 90+ and high lumen outputs of 1335Lm (3000K), 1390Lm (4000K) and 1410Lm (5000K). Large passive heatsink provides effective thermal management ensuring high output and long lifespan.

-  LED: 10.8W / LCP: 13.4W
-  COB Lumens: 1390lm / Luminaire Lumens: 1028lm
-  Lifespan: 50,000 hrs



### Technical Specifications

	3000K	4000K	5000K
COB Lumen Output	1335 lm	1390 lm	1410 lm
Total Luminous Flux	987 WB	1028 WB	1042 WB
Efficacy	79.08 lm/W Wide Beam		
Lifetime	50,000hrs (L70)		
Power Factor	> 0.94		
Input Voltage	100V - 240V AC 50/60 Hz		
Protection	Thermal and Short Circuit		
Dimming	Leading / Trailing edge		

### Dimensions

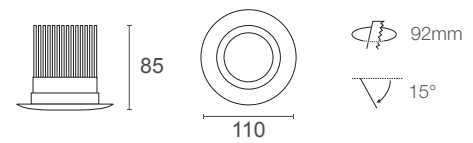

### Trim Colours

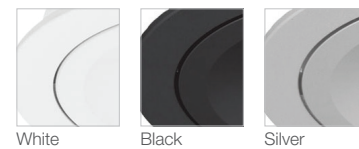

### Order Code

	Colour Temperature	Beam Angle	Trim Colour	Dimming			
XDB10	3	-	WB	-	B	-	Dim
	3	3000K	WB Wide Beam	W	White Trim	Dim	Leading / Trailing
	4	4000K	NB Narrow Beam	B	Black Trim	DALI	DALI Dimming
	5	5000K		S	Silver Trim	1-10	1-10v Dimming

## MINILED XDC10

10 Watt adjustable LED downlight consisting of a single Japanese made COB LED in 3000K, 4000K or 5000K colour temperature options. All colour temperatures have a high colour rendering index (CRI) of 90+ and high lumen outputs of 1335Lm (3000K), 1390Lm (4000K) and 1410Lm (5000K). Large passive heatsink provides effective thermal management ensuring high output and long lifespan.

-  LED: 10.8W / LCP: 13.4W
-  COB Lumens: 1390lm / Luminaire Lumens: 1028lm
-  Lifespan: 50,000 hrs



### Technical Specifications

	3000K	4000K	5000K
COB Lumen Output	1335 lm	1390 lm	1410 lm
Total Luminous Flux	987 WB	1028 WB	1042 WB
Efficacy	79.08 lm/W Wide Beam		
Lifetime	50,000hrs (L70)		
Power Factor	> 0.94		
Input Voltage	100V - 240V AC 50/60 Hz		
Protection	Thermal and Short Circuit		
Dimming	Leading / Trailing edge		

### Dimensions

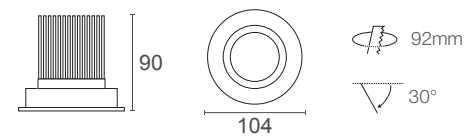

### Trim Colours

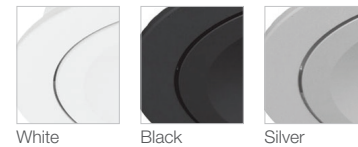

### Order Code

	Colour Temperature	Beam Angle	Trim Colour	Dimming			
XDC10	3	-	WB	-	B	-	Dim
	3	3000K	WB Wide Beam	W	White Trim	Dim	Leading / Trailing
	4	4000K	NB Narrow Beam	B	Black Trim	DALI	DALI Dimming
	5	5000K		S	Silver Trim	1-10	1-10v Dimming



IP44

### MINILED XDF10

10 Watt adjustable LED downlight consisting of a single Japanese made COB LED in 3000K, 4000K or 5000K colour temperature options. All colour temperatures have a high colour rendering index (CRI) of 90+ and high lumen outputs of 1335Lm (3000K), 1390Lm (4000K) and 1410Lm (5000K). Large passive heatsink provides effective thermal management ensuring high output and long lifespan.



-  LED: 10.8W / LCP: 13.4W
-  COB Lumens: 1390lm / Luminaire Lumens: 1028lm
-  Lifespan: 50,000 hrs



#### Technical Specifications

	3000K	4000K	5000K
COB Lumen Output	1335 lm	1390 lm	1410 lm
Total Luminous Flux	987 WB	1028 WB	1042 WB
Efficacy	79.08 lm/W Wide Beam		
Lifetime	50,000hrs (L70)		
Power Factor	> 0.94		
Input Voltage	100V - 240V AC 50/60 Hz		
Protection	Thermal and Short Circuit		
Dimming	Leading / Trailing edge		

#### Dimensions

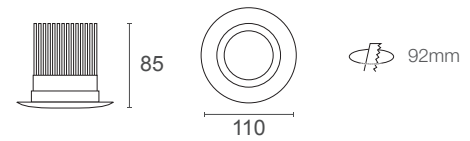

#### Trim Colours

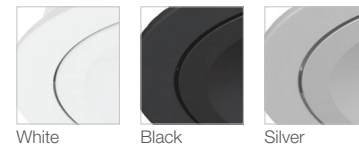

#### Order Code

	Colour Temperature	Beam Angle	Trim Colour	Dimming			
XDF10	3	-	WB	-	B	-	Dim
	3 3000K	WB Wide Beam	W White Trim	Dim	Leading / Trailing		
	4 4000K	NB Narrow Beam	B Black Trim	DALI	DALI Dimming		
	5 5000K		S Silver Trim	1-10	1-10v Dimming		

## MINILED XDH10

10 Watt adjustable LED downlight consisting of a single Japanese made COB LED in 3000K, 4000K or 5000K colour temperature options. All colour temperatures have a high colour rendering index (CRI) of 90+ and high lumen outputs of 1335Lm (3000K), 1390Lm (4000K) and 1410Lm (5000K). Large passive heatsink provides effective thermal management ensuring high output and long lifespan.



-  LED: 10.8W / LCP: 13.4W
-  COB Lumens: 1390lm / Luminaire Lumens: 1028lm
-  Lifespan: 50,000 hrs



### Technical Specifications

	3000K	4000K	5000K
COB Lumen Output	1335 lm	1390 lm	1410 lm
Total Luminous Flux	987 WB	1028 WB	1042 WB
Efficacy	79.08 lm/W Wide Beam		
Lifetime	50,000hrs (L70)		
Power Factor	> 0.94		
Input Voltage	100V - 240V AC 50/60 Hz		
Protection	Thermal and Short Circuit		
Dimming	Leading / Trailing edge		

### Dimensions

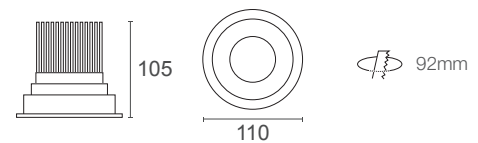

### Trim Colours



### Order Code



	Colour Temperature	Beam Angle	Trim Colour	Dimming				
XDH10	3	-	WB	-	B	-	Dim	
	3	3000K	WB	Wide Beam	W	White Trim	Dim	Leading / Trailing
	4	4000K	NB	Narrow Beam	B	Black Trim	DALI	DALI Dimming
	5	5000K			S	Silver Trim	1-10	1-10v Dimming





### MINILED XDK10

10 Watt adjustable LED downlight consisting of a single Japanese made COB LED in 3000K, 4000K or 5000K colour temperature options. All colour temperatures have a high colour rendering index (CRI) of 90+ and high lumen outputs of 1335Lm (3000K), 1390Lm (4000K) and 1410Lm (5000K). Large passive heatsink provides effective thermal management ensuring high output and long lifespan.

-  LED: 10.8W / LCP: 13.4W
-  COB Lumens: 1390lm / Luminaire Lumens: 1028lm
-  Lifespan: 50,000 hrs



#### Technical Specifications

	3000K	4000K	5000K
COB Lumen Output	1335 lm	1390 lm	1410 lm
Total Luminous Flux	987 WB	1028 WB	1042 WB
Efficacy	79.08 lm/W Wide Beam		
Lifetime	50,000hrs (L70)		
Power Factor	> 0.94		
Input Voltage	100V - 240V AC 50/60 Hz		
Protection	Thermal and Short Circuit		
Dimming	Leading / Trailing edge		

#### Dimensions

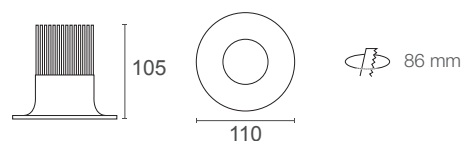

#### Trim Colours





#### Order Code

	Colour Temperature	Beam Angle	Trim Colour	Dimming			
XDK10	3	-	WB	-	B	-	Dim
	3	3000K	WB Wide Beam	W	White Trim	Dim	Leading / Trailing
	4	4000K	NB Narrow Beam	B	Black Trim	DALI	DALI Dimming
	5	5000K		S	Silver Trim	1-10	1-10v Dimming

## MINILED XDR10

10 Watt adjustable LED downlight consisting of a single Japanese made COB LED in 3000K, 4000K or 5000K colour temperature options. All colour temperatures have a high colour rendering index (CRI) of 90+ and high lumen outputs of 1335Lm (3000K), 1390Lm (4000K) and 1410Lm (5000K). Large passive heatsink provides effective thermal management ensuring high output and long lifespan.



-  LED: 10.8W / LCP: 13.4W
-  COB Lumens: 1390lm / Luminaire Lumens: 1119lm
-  Lifespan: 50,000 hrs



### Technical Specifications

	3000K	4000K	5000K
COB Lumen Output	1335 lm	1390 lm	1410 lm
Total Luminous Flux	1074 WB	1119 WB	1135 WB
Efficacy	86.08 lm/W Wide Beam		
Lifetime	50,000hrs (L70)		
Power Factor	> 0.95		
Input Voltage	100V - 240V AC 50/60 Hz		
Protection	Thermal and Short Circuit		
Dimming	Leading / Trailing edge		

### Dimensions

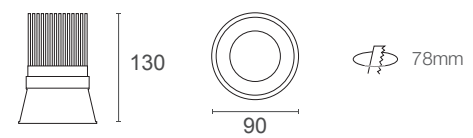

### Trim Colours





### Order Code

	Colour Temperature	Beam Angle	Trim Colour	Dimming				
XDR10	3	-	MB	-	B	-	Dim	
	3	3000K	MB	Medium Beam	W	White Trim	Dim	Leading / Trailing
	4	4000K			B	Black Trim	DALI	DALI Dimming
	5	5000K			S	Silver Trim	1-10	1-10v Dimming



### MINILED XDT10

10 Watt adjustable LED downlight consisting of a single Japanese made COB LED in 3000K, 4000K or 5000K colour temperature options. All colour temperatures have a high colour rendering index (CRI) of 90+ and high lumen outputs of 1335Lm (3000K), 1390Lm (4000K) and 1410Lm (5000K). Large passive heatsink provides effective thermal management ensuring high output and long lifespan.

-  LED: 10.8W / LCP: 13.4W
-  COB Lumens: 1390lm / Luminaire Lumens: 1119lm
-  Lifespan: 50,000 hrs



#### Technical Specifications

	3000K	4000K	5000K
COB Lumen Output	1335 lm	1390 lm	1410 lm
Total Luminous Flux	1074 WB	1119 WB	1135 WB
Efficacy	86.08 lm/W Wide Beam		
Lifetime	50,000hrs (L70)		
Power Factor	> 0.95		
Input Voltage	100V - 240V AC 50/60 Hz		
Protection	Thermal and Short Circuit		
Dimming	Leading / Trailing edge		

#### Dimensions

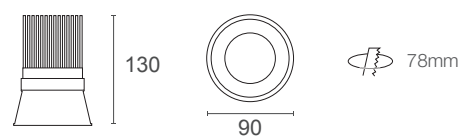

#### Trim Colours



#### Order Code

	Colour Temperature	Beam Angle	Trim Colour	Dimming			
XDT10	3	-	MB	-	B	-	Dim
	3	3000K	MB Medium Beam	W	White Trim	Dim	Leading / Trailing
	4	4000K		B	Black Trim	DALI	DALI Dimming
	5	5000K		S	Silver Trim	1-10	1-10v Dimming

## MINILED XMA10

10 Watt adjustable LED downlight consisting of a single Japanese made COB LED in 3000K, 4000K or 5000K colour temperature options. All colour temperatures have a high colour rendering index (CRI) of 90+ and high lumen outputs of 1335Lm (3000K), 1390Lm (4000K) and 1410Lm (5000K). Large passive heatsink provides effective thermal management ensuring high output and long lifespan.



-  LED: 10.8W / LCP: 13.4W
-  COB Lumens: 1390lm / Luminaire Lumens: 1028lm
-  Lifespan: 50,000 hrs



### Technical Specifications

	3000K	4000K	5000K
COB Lumen Output	1335 lm	1390 lm	1410 lm
Total Luminous Flux	987 WB	1028 WB	1042 WB
Efficacy	86.08 lm/W Wide Beam		
Lifetime	50,000hrs (L70)		
Power Factor	> 0.95		
Input Voltage	100V - 240V AC 50/60 Hz		
Protection	Thermal and Short Circuit		
Dimming	Leading / Trailing edge		

### Dimensions

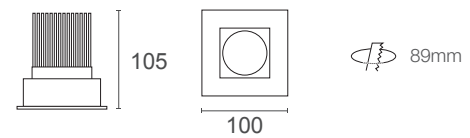

### Trim Colours

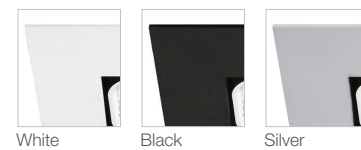

### Order Code

	Colour Temperature	Beam Angle	Trim Colour	Dimming			
XMA10	3	-	WB	-	B	-	Dim
	3	3000K	WB Wide Beam	W	White Trim	Dim	Leading / Trailing
	4	4000K	NB Narrow Beam	B	Black Trim	DALI	DALI Dimming
	5	5000K		S	Silver Trim	1-10	1-10v Dimming

## MINILED XMA210

10 Watt adjustable LED downlight consisting of a single Japanese made COB LED in 3000K, 4000K or 5000K colour temperature options. All colour temperatures have a high colour rendering index (CRI) of 90+ and high lumen outputs of 1335Lm (3000K), 1390Lm (4000K) and 1410Lm (5000K). Large passive heatsink provides effective thermal management ensuring high output and long lifespan.



-  LED: 10.8W / LCP: 13.4W
-  COB Lumens: 1390lm / Luminaire Lumens: 1028lm
-  Lifespan: 50,000 hrs



### Technical Specifications

	3000K	4000K	5000K
COB Lumen Output	2 x 1335 lm	2 x 1390 lm	2 x 1410 lm
Total Luminous Flux	2 x 987 WB	2 x 1028 WB	2 x 1042 WB
Efficacy	86.08 lm/W	Wide Beam	
Lifetime	50,000hrs (L70)		
Power Factor	> 0.95		
Input Voltage	100V - 240V AC 50/60 Hz		
Protection	Thermal and Short Circuit		
Dimming	Leading / Trailing edge		

### Dimensions

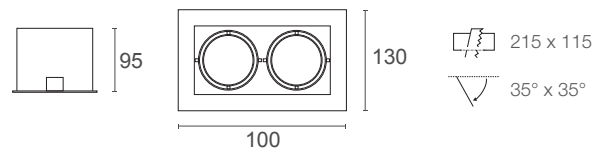

### Trim Colours





### Order Code

	Colour Temperature	Beam Angle	Trim Colour	Dimming				
XMA210	3	-	WB	-	B	-	Dim	
	3	3000K	WB	Wide Beam	W	White Trim	Dim	Leading / Trailing
	4	4000K	NB	Narrow Beam	B	Black Trim	DALI	DALI Dimming
	5	5000K			S	Silver Trim	1-10	1-10v Dimming

## MINILED XMA310

10 Watt adjustable LED downlight consisting of a single Japanese made COB LED in 3000K, 4000K or 5000K colour temperature options. All colour temperatures have a high colour rendering index (CRI) of 90+ and high lumen outputs of 1335Lm (3000K), 1390Lm (4000K) and 1410Lm (5000K). Large passive heatsink provides effective thermal management ensuring high output and long lifespan.



-  LED: 10.8W / LCP: 13.4W
-  COB Lumens: 1390lm / Luminaire Lumens: 1028lm
-  Lifespan: 50,000 hrs



### Technical Specifications

	3000K	4000K	5000K
COB Lumen Output	3 x 1335 lm	3 x 1390 lm	3 x 1410 lm
Total Luminous Flux	3 x 987 WB	3 x 1028 WB	3 x 1042 WB
Efficacy	86.08 lm/W Wide Beam		
Lifetime	50,000hrs (L70)		
Power Factor	> 0.95		
Input Voltage	100V - 240V AC 50/60 Hz		
Protection	Thermal and Short Circuit		
Dimming	Leading / Trailing edge		

### Dimensions

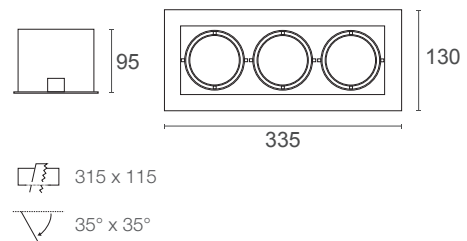

### Trim Colours

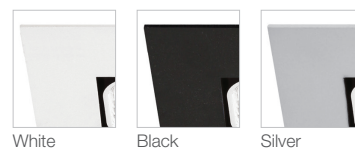

### Order Code

	Colour Temperature	Beam Angle	Trim Colour	Dimming			
XMA310	3	-	WB	-	B	-	Dim
	3	3000K	WB Wide Beam	W	White Trim	Dim	Leading / Trailing
	4	4000K	NB Narrow Beam	B	Black Trim	DALI	DALI Dimming
	5	5000K		S	Silver Trim	1-10	1-10v Dimming



IP54

### MINILED XDV10

10 Watt adjustable LED downlight consisting of a single Japanese made COB LED in 3000K, 4000K or 5000K colour temperature options. All colour temperatures have a high colour rendering index (CRI) of 90+ and high lumen outputs of 1335Lm (3000K), 1390Lm (4000K) and 1410Lm (5000K). Large passive heatsink provides effective thermal management ensuring high output and long lifespan.

-  LED: 10.8W / LCP: 13.4W
-  COB Lumens: 1390lm / Luminaire Lumens: 1028lm
-  Lifespan: 50,000 hrs



#### Technical Specifications

	3000K	4000K	5000K
COB Lumen Output	1335 lm	1390 lm	1410 lm
Total Luminous Flux	987 WB	1028 WB	1042 WB
Efficacy	86.08 lm/W Wide Beam		
Lifetime	50,000hrs (L70)		
Power Factor	> 0.95		
Input Voltage	100V - 240V AC 50/60 Hz		
Protection	Thermal and Short Circuit		
Dimming	Leading / Trailing edge		

#### Dimensions

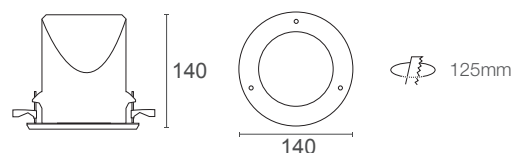

#### Trim Colours

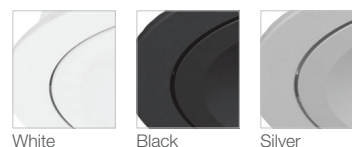

#### Order Code

	Colour Temperature	Beam Angle	Trim Colour	Dimming				
XDV10	3	-	WB	-	B	-	Dim	
	3	3000K	WB	Wide Beam	W	White Trim	Dim	Leading / Trailing
	4	4000K	NB	Narrow Beam	B	Black Trim	DALI	DALI Dimming
	5	5000K			S	Silver Trim	1-10	1-10v Dimming

## MINILED XDS

10, 15 or 26 Watt LED fixed downlight consisting of a single Japanese made LED chip in 3000K, 4000K or 5000K colour temperature options. All colour temperatures have a high colour rendering index (CRI) of 90+ and high COB lumen outputs. Sealed face with silicone gasket for increased ingress protection and large passive heatsink for effective thermal management ensuring high output and long lifespan.



- LED: 10.8W / LCP: 13.4W
- LED: 15W / LCP: 18.2W
- LED: 26W / LCP: 31W
- COB Lumens: 1170lm
- COB Lumens: 1650lm
- COB Lumens: 3170lm
- Lifespan: 50,000 hrs



### Technical Specifications

XDS10	3000K	4000K	5000K
COB Lumen Output	1335 lm	1390 lm	1410 lm
XDS15	3000K	4000K	5000K
COB Lumen Output	1585 lm	1650 lm	1675 lm
XDS26	3000K	4000K	5000K
COB Lumen Output	3035 lm	3170 lm	3205 lm
Lifetime	50,000hrs (L70)		
Power Factor	> 0.95		
Input Voltage	100V - 240V AC 50/60 Hz		
Protection	Thermal and Short Circuit		
Dimming	Leading / Trailing edge		Available on request DALI* 1-10v*

### Dimensions

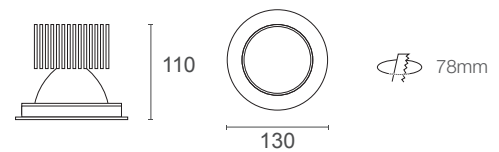

### Trim Colours



### Order Code

	Colour Temperature	Beam Angle	Trim Colour	Dimming				
XDS15	3	-	WB	-	B	-	Dim	
	3	3000K	WB	Wide Beam	W	White Trim	Dim	Leading / Trailing
	4	4000K	NB	Narrow Beam	B	Black Trim	DALI	DALI Dimming
	5	5000K			S	Silver Trim	1-10	1-10v Dimming





### MINILED XDM26

Recessed LED downlight consisting of a single 26W Japanese made LED with wide beam angle. Sealed face with silicone gasket for added protection. High Colour rendering index (CRI) of 85 and high COB lumen outputs of 3035Lm (3000K), 3170Lm (4000K) and 3205Lm (5000K). Anodized black heatsink for effective thermal management ensuring high output and long lifespan.

LED: 26W / LCP: 26.4W

COB Lumens: 3170lm / Luminaire Lumens: 2041lm

Lifespan: 50,000 hrs



#### Technical Specifications

	3000K	4000K	5000K
COB Lumen Output	3035 lm	3170 lm	3205 lm
Total Luminous Flux	1954 WB	2041 WB	2063 WB
Efficacy	78.5 lm/W	Wide Beam	
Lifetime	50,000hrs (L70)		
Power Factor	> 0.95		
Input Voltage	100V - 240V AC 50/60 Hz		
Protection	Thermal and Short Circuit		
Dimming	Leading / Trailing edge		

#### Dimensions

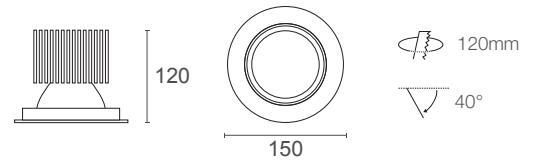

#### Trim Colours



#### Order Code

	Colour Temperature	Beam Angle	Trim Colour	Dimming				
XDM26	3	-	WB	-	B	-	Dim	
	3	3000K	WB	Wide Beam	W	White Trim	Dim	Leading / Trailing
	4	4000K	NB	Narrow Beam	B	Black Trim	DALI	DALI Dimming
	5	5000K			S	Silver Trim	1-10	1-10v Dimming

## MINILED XDF26

Recessed LED downlight consisting of a single 26W Japanese made LED with wide beam angle. Sealed face with silicone gasket for added protection. High Colour rendering index (CRI) of 85 and high COB lumen outputs of 3035Lm (3000K), 3170Lm (4000K) and 3205Lm (5000K). Anodized black heatsink for effective thermal management ensuring high output and long lifespan.

IP44



-  LED: 26W / LCP: 26.4W
-  COB Lumens: 3170lm / Luminaire Lumens: 2041lm
-  Lifespan: 50,000 hrs



### Technical Specifications

	3000K	4000K	5000K
COB Lumen Output	3035 lm	3170 lm	3205 lm
Total Luminous Flux	1954 WB	2041 WB	2063 WB
Efficacy	78.5 lm/W	Wide Beam	
Lifetime	50,000hrs (L70)		
Power Factor	> 0.95		
Input Voltage	100V - 240V AC 50/60 Hz		
Protection	Thermal and Short Circuit		
Dimming	Leading / Trailing edge		

### Dimensions

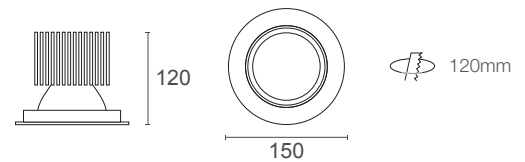

### Trim Colours







### Order Code

	Colour Temperature	Beam Angle	Trim Colour	Dimming				
XDF26	3	-	WB	-	B	-	Dim	
	3	3000K	WB	Wide Beam	W	White Trim	Dim	Leading / Trailing
	4	4000K	NB	Narrow Beam	B	Black Trim	DALI	DALI Dimming
	5	5000K			S	Silver Trim	1-10	1-10v Dimming



### MIDILED XRS

Recessed LED downlight with adjustable 'pull-out' gimbal design for versatile lighting applications. Wide beam angle and 80° tilt adjustment allows for perfect illumination for vertical shelves, signage and merchandising. Available in high output 15W and 26W Japanese made LED with a high colour rendering index (CRI) of 85 and COB lumen outputs. Anodized black heatsink provides effective thermal management ensuring high output and long lifespan. Supplied with remote electronic driver.

-  LED: 15W / LCP: 18.2W
-  LED: 26W / LCP: 26.4W
-  COB Lumens: 1650lm
-  COB Lumens: 3170lm
-  Lifespan: 50,000 hrs



#### Technical Specifications

XRS15	3000K	4000K	5000K
COB Lumen Output	1585 lm	1650 lm	1675 lm

XRS26	3000K	4000K	5000K
COB Lumen Output	3035 lm	3170 lm	3205 lm

Lifetime	50,000 hrs (L70)
Power Factor	> 0.95
Input Voltage	100V - 240V AC 50/60 Hz
Protection	Thermal and Short Circuit

Dimming	Leading / Trailing edge	Available on request DALI* 1-10v*
---------	-------------------------	--------------------------------------

#### Dimensions

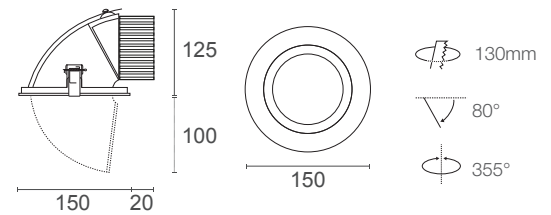

#### Trim Colours

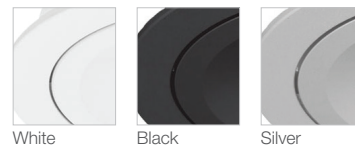

#### Order Code

	Wattage	Colour Temperature	Beam Angle	Trim Colour	Dimming		
XRS	15	-	3	-	WB	B	Dim
	15 15W	3 3000K	WB Wide Beam	W White Trim	Dim Leading / Trailing		
	26 26W	4 4000K	NB Narrow Beam	B Black Trim	DALI DALI Dimming		
		5 5000K		S Silver Trim	1-10 1-10v Dimming		

## MINILED XMB26

Recessed Square LED downlight available in a one, two or three light combinations, consisting of single 26W Japanese made LED's. High Colour rendering index (CRI) of 85 and high COB lumen outputs of 2300Lm (3000K), 2450Lm (4000K) and 2600Lm (5000K). Anodized black heatsink for effective thermal management ensuring high output and long lifespan.



-  LED: 26W / LCP: 26.4W
-  COB Lumens: 3170lm / Luminaire Lumens: 2041lm
-  Lifespan: 50,000 hrs



### Technical Specifications

	3000K	4000K	5000K
COB Lumen Output	3035 lm	3170 lm	3205 lm
Total Luminous Flux	1954 WB	2041 WB	2063 WB
Efficacy	78.5 lm/W	Wide Beam	
Lifetime	50,000hrs (L70)		
Power Factor	> 0.95		
Input Voltage	100V - 240V AC 50/60 Hz		
Protection	Thermal and Short Circuit		
Dimming	Leading / Trailing edge		

### Dimensions

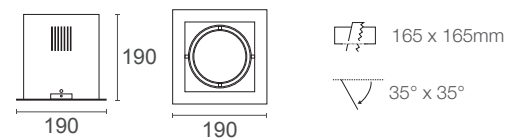

### Trim Colours

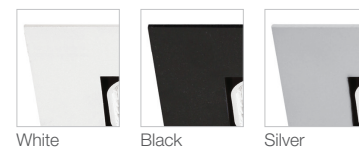



### Order Code

	Colour Temperature	Beam Angle	Trim Colour	Dimming
XMB26	3	-	WB	-
	3 3000K	WB Wide Beam	W White Trim	Dim Leading / Trailing
	4 4000K		B Black Trim	DALI DALI Dimming
	5 5000K		S Silver Trim	1-10 1-10v Dimming



### MINILED XMB226

Recessed Square LED downlight available in a one, two or three light combinations, consisting of single 26W Japanese made LED's. High Colour rendering index (CRI) of 85 and high COB lumen outputs of 2300Lm (3000K), 2450Lm (4000K) and 2600Lm (5000K). Anodized black heatsink for effective thermal management ensuring high output and long lifespan.

-  LED: 2 x 26W / LCP: 2 x 26.4W
-  COB Lumens: 2 x 3170lm / Luminaire Lumens: 2 x 2041lm
-  Lifespan: 50,000 hrs



#### Technical Specifications

	3000K	4000K	5000K
COB Lumen Output	3 x 3035 lm	3 x 3170 lm	3 x 3205 lm
Total Luminous Flux	3 x 1954 WB	3 x 2041 WB	3 x 2063 WB
Efficacy	78.5 lm/W	Wide Beam	
Lifetime	50,000hrs (L70)		
Power Factor	> 0.95		
Input Voltage	100V - 240V AC 50/60 Hz		
Protection	Thermal and Short Circuit		
Dimming	Leading / Trailing edge		

#### Dimensions

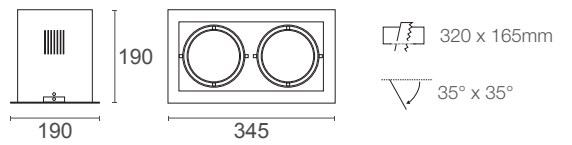

#### Trim Colours

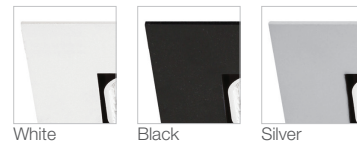



#### Order Code

	Colour Temperature	Beam Angle	Trim Colour	Dimming				
XMB226	3	-	WB	-	B	-	Dim	
	3	3000K	WB	Wide Beam	W	White Trim	Dim	Leading / Trailing
	4	4000K			B	Black Trim	DALI	DALI Dimming
	5	5000K			S	Silver Trim	1-10	1-10v Dimming

## MINILED XMB326

Recessed Square LED downlight available in a one, two or three light combinations, consisting of single 26W Japanese made LED's. High Colour rendering index (CRI) of 85 and high COB lumen outputs of 2300Lm (3000K), 2450Lm (4000K) and 2600Lm (5000K). Anodized black heatsink for effective thermal management ensuring high output and long lifespan.



-  LED: 3 x 26W / LCP: 3 x 26.4W
-  COB Lumens: 3 x 3170lm / Luminaire Lumens: 3 x 2041lm
-  Lifespan: 50,000 hrs



### Technical Specifications

	3000K	4000K	5000K
COB Lumen Output	3 x 3035 lm	3 x 3170 lm	3 x 3205 lm
Total Luminous Flux	3 x 1954 WB	3 x 2041 WB	3 x 2063 WB
Efficacy	78.5 lm/W	Wide Beam	
Lifetime	50,000hrs (L70)		
Power Factor	> 0.95		
Input Voltage	100V - 240V AC 50/60 Hz		
Protection	Thermal and Short Circuit		
Dimming	Leading / Trailing edge		

### Dimensions

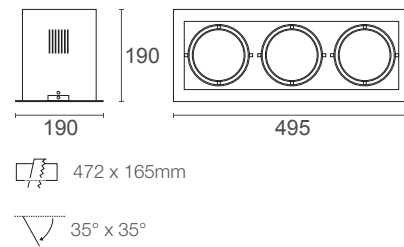

### Trim Colours



### Order Code

	Colour Temperature	Beam Angle	Trim Colour	Dimming				
XMB326	3	-	WB	-	B	-	Dim	
	3	3000K	WB	Wide Beam	W	White Trim	Dim	Leading / Trailing
	4	4000K			B	Black Trim	DALI	DALI Dimming
	5	5000K			S	Silver Trim	1-10	1-10v Dimming



### MIDILED XDL

40 and 60 Watt adjustable LED downlight in 3000K, 4000K or 5000K colour temperature options. All colour temperatures have a high colour rendering index (CRI) of 85 and high COB lumen outputs. Sealed face with silicone gasket for increased ingress protection. Large pressure cast aluminium heatsink provides effective thermal management ensuring high output and long lifespan.

- ⚡ LED: 40W / LCP: 41.4W
- ⚡ LED: 60W / LCP: 63.1W
- ☀️ COB Lumens: 4000lm
- ☀️ COB Lumens: 5800lm
- 🕒 Lifespan: 50,000 hrs



#### Technical Specifications

XDL40	3000K	4000K	5000K
COB Lumen Output	3200 lm	4000 lm	4200 lm
Total Luminous Flux	2344 WB	2931 WB	3077 WB
Efficacy	71 lm/W	Wide Beam	

XDL60	3000K	4000K	5000K
COB Lumen Output	5600 lm	5800 lm	6100 lm
Total Luminous Flux	4103 WB	4250 WB	4470 WB
Efficacy	71 lm/W	Wide Beam	

Lifetime	50,000hrs (L70)
Power Factor	> 0.95
Input Voltage	100V - 240V AC 50/60 Hz
Protection	Thermal and Short Circuit

Dimming	Leading / Trailing edge	Available on request DALI* 1-10v*
---------	-------------------------	--------------------------------------

#### Dimensions

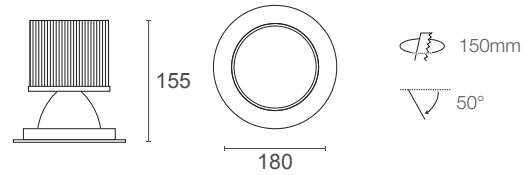

#### Trim Colours

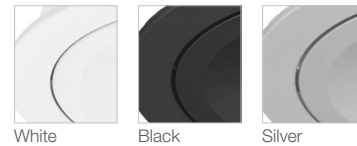

#### Order Code





	Wattage	Colour Temperature	Beam Angle	Trim Colour	Dimming			
XDL	40	-	3	-	WB	-	B	Dim
	40 40W	3 3000K	WB Wide Beam	W White Trim	Dim	Leading / Trailing		
	60 60W	4 4000K	NB Narrow Beam	B Black Trim	DALI	DALI Dimming		
		5 5000K		S Silver Trim	1-10	1-10v Dimming		

## MIDILED XDF

40 and 60 Watt adjustable LED downlight in 3000K, 4000K or 5000K colour temperature options. All colour temperatures have a high colour rendering index (CRI) of 85 and high COB lumen outputs. Sealed face with silicone gasket for increased ingress protection. Large pressure cast aluminium heatsink provides effective thermal management ensuring high output and long lifespan.

IP44



-  LED: 40W / LCP: 41.4W
-  LED: 60W / LCP: 63.1W
-  COB Lumens: 4000lm
-  COB Lumens: 5800lm
-  Lifespan: 50,000 hrs



### Technical Specifications

XDF40	3000K	4000K	5000K
COB Lumen Output	3200 lm	4000 lm	4200 lm
Total Luminous Flux	2344 WB	2931 WB	3077 WB
Efficacy	71 lm/W	Wide Beam	

XDF60	3000K	4000K	5000K
COB Lumen Output	5600 lm	5800 lm	6100 lm
Total Luminous Flux	4103 WB	4250 WB	4470 WB
Efficacy	71 lm/W	Wide Beam	

Lifetime	50,000hrs (L70)
Power Factor	> 0.95
Input Voltage	100V - 240V AC 50/60 Hz
Protection	Thermal and Short Circuit

Dimming	Leading / Trailing edge	Available on request DALI* 1-10V*
---------	-------------------------	--------------------------------------

### Dimensions

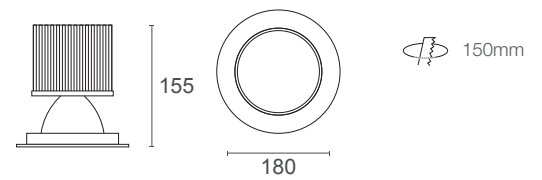

### Trim Colours



### Order Code

	Wattage	Colour Temperature	Beam Angle	Trim Colour	Dimming					
XDF	40	-	3	-	WB	-	B	Dim		
	40	40W	3	3000K	WB	Wide Beam	W	White Trim	Dim	Leading / Trailing
	60	60W	4	4000K	NB	Narrow Beam	B	Black Trim	DALI	DALI Dimming
			5	5000K			S	Silver Trim	1-10	1-10v Dimming





### MIDILED XDE

40 and 60 watt LED downlight consisting of 4 Japanese made LED's in 3000K, 4000K and 5000K. All colour temperatures have a high colour rendering index (CRI) and high COB lumen outputs. Anodized pressure cast heatsink provides effective thermal management ensuring high output and long lifespan.

- ⚡ LED: 43.2W / LCP: 46.7W
- ⚡ LED: 60W / LCP: 64.5W
- ☀️ COB Lumens: 5560lm
- ☀️ COB Lumens: 6620lm
- 🕒 Lifespan: 50,000 hrs



#### Technical Specifications

XDE40	3000K	4000K	5000K
COB Lumen Output	5340 lm	5560 lm	5640 lm
XDE60	3000K	4000K	5000K
COB Lumen Output	6340 lm	6620 lm	6680 lm
Lifetime	50,000 hrs (L70)		
Power Factor	> 0.95		
Input Voltage	100V - 240V AC 50/60 Hz		
Protection	Thermal and Short Circuit		
Dimming	Leading / Trailing edge		Available on request DALI* 1-10v*

#### Dimensions

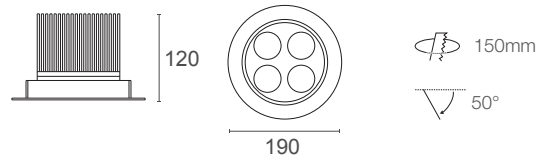

#### Trim Colours

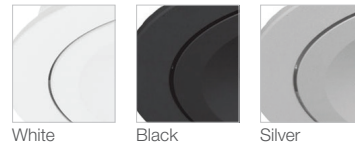

#### Order Code





	Wattage	Colour Temperature	Beam Angle	Trim Colour	Dimming
XDE	40	3	WB	B	Dim
	40 40W	3 3000K	WB Wide Beam	W White Trim	Dim Leading / Trailing
	60 60W	4 4000K	NB Narrow Beam	B Black Trim	DALI DALI Dimming
		5 5000K		S Silver Trim	1-10 1-10v Dimming





### MIDILED XPF

40 and 60 Watt adjustable LED downlight consisting of 4 Japanese made LED's in 3000K, 4000K and 5000K. All colour temperatures have a high colour rendering index (CRI) of 85 and high lumen outputs. Available in wide, medium and narrow beam angles. Large passive heatsink provides effective thermal management ensuring high output and long lifespan.

-  LED: 43.2W / LCP: 46.7W
-  LED: 60W / LCP: 64.5W
-  COB Lumens: 5560lm
-  COB Lumens: 6620lm
-  Lifespan: 50,000 hrs



#### Technical Specifications

XPF40	3000K	4000K	5000K
COB Lumen Output	5340 lm	5560 lm	5640 lm
XPF60	3000K	4000K	5000K
COB Lumen Output	6340 lm	6620 lm	6680 lm
Lifetime	50,000 hrs (L70)		
Power Factor	> 0.95		
Input Voltage	100V - 240V AC 50/60 Hz		
Protection	Thermal and Short Circuit		
Dimming	Leading / Trailing edge		Available on request DALI* 1-10v*

#### Dimensions

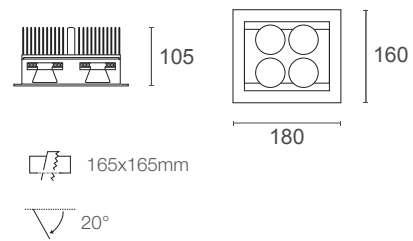

#### Trim Colours

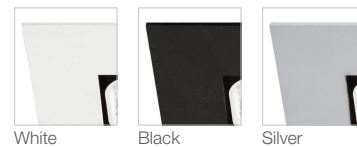

#### Order Code

	Wattage	Colour Temperature	Beam Angle	Trim Colour	Dimming			
XPF	40	-	3	-	WB	-	B	Dim
	40 40W	3 3000K	WB Wide Beam	W White Trim	Dim Leading / Trailing			
	60 60W	4 4000K	NB Narrow Beam	B Black Trim	DALI DALI Dimming			
		5 5000K		S Silver Trim	1-10 1-10v Dimming			

## MIDILED XMW

Wide beam 40 and 60 watt square LED downlight consisting of 4 Japanese made LED's with square symmetrical beam reflectors in 3000K, 4000K and 5000K. All colour temperatures have a high colour rendering index (CRI) of 85+ and high COB lumen outputs. Large passive heatsink provides effective thermal management ensuring high output and long lifespan.



- ⚡ LED: 43.2W / LCP: 46.7W
- ⚡ LED: 60W / LCP: 64.5W
- 💡 COB Lumens: 5560lm
- 💡 COB Lumens: 6620lm
- 🕒 Lifespan: 50,000 hrs



### Technical Specifications

XMW40	3000K	4000K	5000K
COB Lumen Output	5340 lm	5560 lm	5640 lm
Total Luminous Flux	3880 WB	4057 WB	4094 WB
Efficacy	87 lm/W	Wide Beam	

XMW60	3000K	4000K	5000K
COB Lumen Output	6340 lm	6620 lm	6680 lm
Total Luminous Flux	5820 WB	6086 WB	6141 WB
Efficacy	99 lm/W	Wide Beam	

  

Lifetime	50,000hrs (L70)		
Power Factor	> 0.95		
Input Voltage	100V - 240V AC 50/60 Hz		
Protection	Thermal and Short Circuit		

Dimming	Leading / Trailing edge	Available on request DALI* 1-10v*	
---------	-------------------------	--------------------------------------	--

### Dimensions

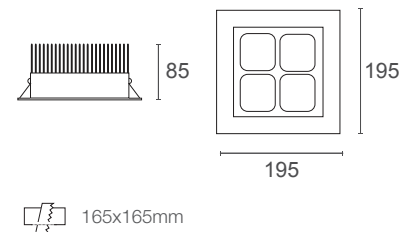

### Trim Colours





### Order Code

	Wattage	Colour Temperature	Beam Angle	Trim Colour	Dimming	
XMW	40	-	3	-	B	Dim
	40 40W	3 3000K	WB Wide Beam	W White Trim	Dim Leading / Trailing	
	60 60W	4 4000K	NB Narrow Beam	B Black Trim	DALI DALI Dimming	
		5 5000K		S Silver Trim	1-10 1-10v Dimming	



### MINILED XFS40

40W LED Shop lights featuring 65° drop out tilt design for versatile lighting applications. With a wide horizontal beam distribution and high 85+ CRI the XFS40 is ideal for illuminating vertical surfaces such as signage, merchandising or shelving. Available in 3000K, 4000K and 5000K colour temperature options with high COB lumen outputs of 3800Lm (3000K), 4000Lm (4000K) and 4200Lm (5000K). Black anodized aluminium heatsink provides effective thermal management ensuring high light output and long lifespan.

-  LED: 40W / LCP: 41W
-  COB Lumens: 4000lm
-  Lifespan: 50,000 hrs



#### Technical Specifications

	3000K	4000K	5000K
COB Lumen Output	3035 lm	3170 lm	3205 lm
Lifetime	50,000hrs (L70)		
Power Factor	> 0.95		
Input Voltage	100V - 240V AC 50/60 Hz		
Protection	Thermal and Short Circuit		
Dimming	Leading / Trailing edge		

#### Dimensions

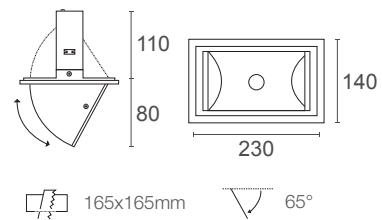

#### Trim Colours







#### Order Code

	Colour Temperature	Beam Angle	Trim Colour	Dimming				
XFS40	3	-	WB	-	B	-	Dim	
	3	3000K	WB	Wide Beam	W	White Trim	Dim	Leading / Trailing
	4	4000K			B	Black Trim	DALI	DALI Dimming
	5	5000K			S	Silver Trim	1-10	1-10v Dimming

## MEGALED XLA

40 and 60 Watt LED downlight featuring large diameter and cut-out ideal for use in place of existing CFL downlights. Available in 3000K, 4000K and 5000K colour temperature options with a high CRI of 85+ and a high COB lumen output of up to 6680Lm (60W / 5000K). Black anodized pressure cast aluminium heatsink provides effective thermal management ensuring high output and long lifespan.



-  LED: 40W / LCP: 41.4W
-  LED: 60W / LCP: 63.1W
-  COB Lumens: 4000lm
-  COB Lumens: 5800lm
-  Lifespan: 50,000 hrs



### Technical Specifications

XLA40	3000K	4000K	5000K
COB Lumen Output	3800 lm	4000 lm	4200 lm
Total Luminous Flux	3040 WB	3201 WB	3360 WB
Efficacy	77.3 lm/W	Wide Beam	

XLA60	3000K	4000K	5000K
COB Lumen Output	5600 lm	5800 lm	6100 lm
Total Luminous Flux	4480 WB	4640 WB	4880 WB
Efficacy	73.5 lm/W	Wide Beam	

  

Lifetime	50,000hrs (L70)
Power Factor	> 0.95
Input Voltage	100V - 240V AC 50/60 Hz
Protection	Thermal and Short Circuit

  

Dimming	Leading / Trailing edge	Available on request
		DALI* 1-10v*

### Dimensions

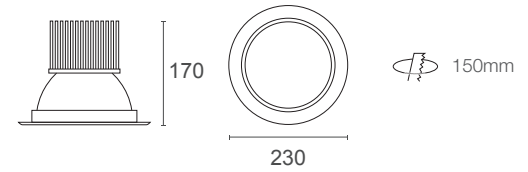

### Trim Colours

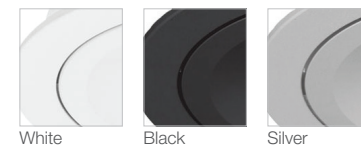





### Order Code

	Wattage	Colour Temperature	Beam Angle	Trim Colour	Dimming					
XLA	40	-	3	-	WB	-	B	Dim		
	40	40W	3	3000K	WB	Wide Beam	W	White Trim	Dim	Leading / Trailing
	60	60W	4	4000K	NB	Narrow Beam	B	Black Trim	DALI	DALI Dimming
			5	5000K			S	Silver Trim	1-10	1-10v Dimming



### MEGALED XLB

40 and 60 Watt LED downlight featuring large diameter and cut-out ideal for use in place of existing CFL downlights. Available in 3000K, 4000K and 5000K colour temperature options with a high CRI of 90+ and a high COB lumen output of up to 6100Lm (60W / 5000K). Sealed face with silicone gasket for increased ingress protection. Black anodized pressure cast aluminium heatsink provides effective thermal management ensuring high output and long lifespan.

-  LED: 40W / LCP: 41.4W
-  LED: 60W / LCP: 63.1W
-  COB Lumens: 4000lm
-  COB Lumens: 5800lm
-  Lifespan: 50,000 hrs



#### Technical Specifications

XLB40	3000K	4000K	5000K
COB Lumen Output	3800 lm	4000 lm	4200 lm
Total Luminous Flux	3040 WB	3201 WB	3360 WB
Efficacy	77.3 lm/W	Wide Beam	

XLB60	3000K	4000K	5000K
COB Lumen Output	5600 lm	5800 lm	6100 lm
Total Luminous Flux	4480 WB	4640 WB	4880 WB
Efficacy	73.5 lm/W	Wide Beam	

Lifetime	50,000hrs (L70)
Power Factor	> 0.95
Input Voltage	100V - 240V AC 50/60 Hz
Protection	Thermal and Short Circuit

Dimming	Leading / Trailing edge	Available on request DALI* 1-10V*
---------	-------------------------	--------------------------------------

#### Dimensions

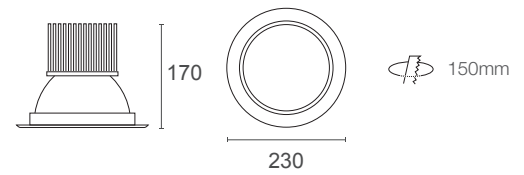

#### Trim Colours

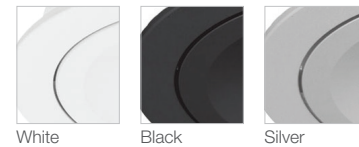

#### Order Code





	Wattage	Colour Temperature	Beam Angle	Trim Colour	Dimming					
XLB	40	-	3	-	WB	-	B	Dim		
	40	40W	3	3000K	WB	Wide Beam	W	White Trim	Dim	Leading / Trailing
	60	60W	4	4000K	NB	Narrow Beam	B	Black Trim	DALI	DALI Dimming
			5	5000K			S	Silver Trim	1-10	1-10v Dimming



## LED SPOT XTS10 & XTS15

Track mounted led spotlight with integral driver and three circuit track adaptor. Manufactured with a single 10W or 15W Japanese made LED with a high colour rendering index of 85+ and a high COB lumen output. Fully adjustable design with 350° rotation and 200° tilt.



-  LED: 10.8W / LCP: 13.5W
-  LED: 15W / LCP: 18.2W
-  COB Lumens: 1170lm
-  COB Lumens: 1650lm
-  Lifespan: 50,000 hrs



### Technical Specifications

XTS10	3000K	4000K	5000K
COB Lumen Output	1150 lm	1170 lm	1215 lm
Total Luminous Flux	987 WB	1028 WB	1042 WB
Efficacy	77.3 lm/W	Wide Beam	

  

XTS15	3000K	4000K	5000K
COB Lumen Output	1585 lm	1650 lm	1675 lm

Lifetime	50,000hrs (L70)
Power Factor	> 0.95
Input Voltage	100V - 240V AC 50/60 Hz
Protection	Thermal and Short Circuit
Dimming	Leading / Trailing edge <span style="float: right;">Available on request</span> DALI* 1-10v*

### Dimensions

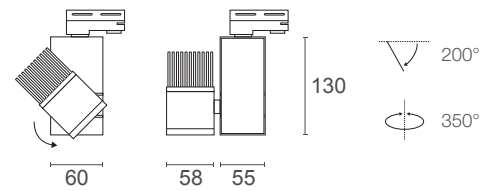

### Trim Colours



### Order Code



	Wattage	Colour Temperature	Beam Angle	Trim Colour	Dimming					
XLA	40	-	3	-	WB	B	Dim			
	40	40W	3	3000K	WB	Wide Beam	W	White Trim	Dim	Leading / Trailing
	60	60W	4	4000K	NB	Narrow Beam	B	Black Trim	DALI	DALI Dimming
			5	5000K			S	Silver Trim	1-10	1-10v Dimming





### LED SPOT XTS26

Track mounted led spotlight with integral driver and three circuit track adaptor. Manufactured with a single 26W Japanese made LED with a high colour rendering index of 85+ and high COB lumen outputs of 3035Lm (3000K), 3170Lm (4000K) and 3205Lm (5000K). Fully adjustable design with 360° rotation and 180° tilt. Anodized black heatsink provides effective thermal management ensuring high output and long lifespan.

-  LED: 25W / LCP: 26.4W
-  COB Lumens: 3170lm
-  Lifespan: 50,000 hrs



#### Technical Specifications

	3000K	4000K	5000K
COB Lumen Output	3035 lm	3170 lm	3205 lm
Lifetime	50,000hrs (L70)		
Power Factor	> 0.95		
Input Voltage	100V - 240V AC 50/60 Hz		
Protection	Thermal and Short Circuit		
Dimming	Leading / Trailing edge		

#### Dimensions

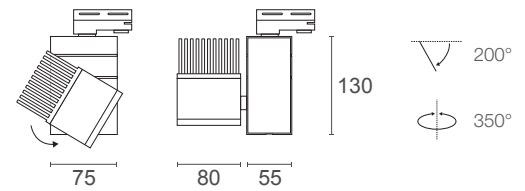

#### Trim Colours





#### Order Code

	Colour Temperature	Beam Angle	Trim Colour	Dimming				
XTS26	3	-	WB	-	B	-	Dim	
	3	3000K	WB	Wide Beam	W	White Trim	Dim	Leading / Trailing
	4	4000K			B	Black Trim	DALI	DALI Dimming
	5	5000K			S	Silver Trim	1-10	1-10v Dimming

## LED SPOT XTS40

Track mounted led spotlight with integral driver and three circuit track adaptor. Manufactured with a single 26W Japanese made LED with a high colour rendering index of 85+ and high COB lumen outputs of 2615Lm (3000K), 2690Lm (4000K) and 2765Lm (5000K). Fully adjustable design with 350° rotation and 200° tilt. Anodized black heatsink provides effective thermal management ensuring high output and long lifespan.

-  LED: 40W / LCP: 42W
-  COB Lumens: 4000lm
-  Lifespan: 50,000 hrs



### Technical Specifications

	3000K	4000K	5000K
COB Lumen Output	3800 lm	4000 lm	4200 lm
Total Luminous Flux	2655 WB	2795 WB	2935 WB
Efficacy	72 lm/W	Wide Beam	
Lifetime	50,000hrs (L70)		
Power Factor	> 0.95		
Input Voltage	100V - 240V AC 50/60 Hz		
Protection	Thermal and Short Circuit		
Dimming	Leading / Trailing edge		Available on request DALI* 1-10v*

### Dimensions

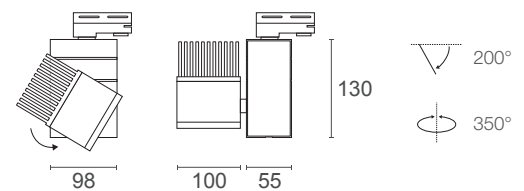

### Trim Colours





### Order Code

	Colour Temperature	Beam Angle	Trim Colour	Dimming			
XTS40	3	-	WB	-	B	-	Dim
	3 3000K	WB Wide Beam	W White Trim	Dim Leading / Trailing			
	4 4000K	NB Narrow Beam	B Black Trim	DALI DALI Dimming			
	5 5000K		S Silver Trim	1-10 1-10v Dimming			



### LED SPOT XTL40

Track mounted led spotlight with integral driver and three circuit track adapter. Manufactured with a single 40W Japanese made LED with a high colour rendering index of 85+ and high COB lumen outputs of 3800Lm (3000K), 4000Lm (4000K) and 4200Lm (5000K). Fully adjustable design with 350° rotation and 200° tilt.

-  LED: 40W / LCP: 42W
-  COB Lumens:4000lm
-  Lifespan: 50,000 hrs



#### Technical Specifications

	3000K	4000K	5000K
COB Lumen Output	3800 lm	4000 lm	4200 lm
Lifetime	50,000hrs (L70)		
Power Factor	> 0.95		
Input Voltage	100V - 240V AC 50/60 Hz		
Protection	Thermal and Short Circuit		
Dimming	Leading / Trailing edge		Available on request DALI* 1-10V*

#### Dimensions

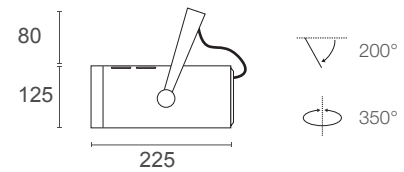

#### Trim Colours



#### Order Code

	Colour Temperature	Beam Angle	Trim Colour	Dimming			
XTL40	3	-	WB	-	B	-	Dim
	3 3000K	WB Wide Beam	W White Trim	Dim Leading / Trailing			
	4 4000K		B Black Trim	DALI DALI Dimming			
	5 5000K						

## TRA3C

240V 3-circuit track enabling up to 3 lighting configurations to be set on one track and be controlled and switched individually. Supplied with wire suspension wire kit.

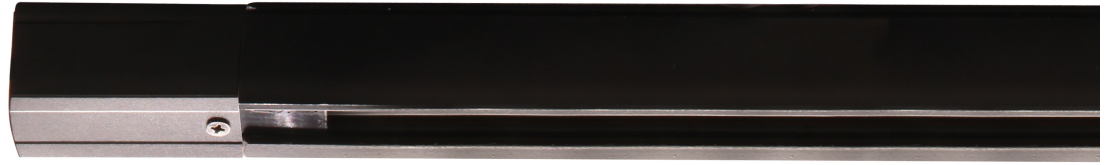

### Dimensions

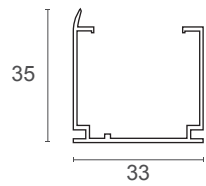

### Trim Colours



White

Black

Silver

### Order Code

		Trim Colour	Length	
TRA3C	-	<b>B</b>	-	2500mm
		W	White Trim	xx mm MAX 3000mm per individual length
		B	Black Trim	
		S	Silver Trim	

### Track Accessories

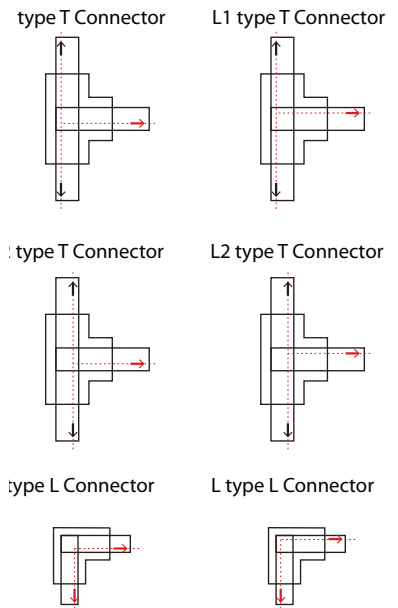
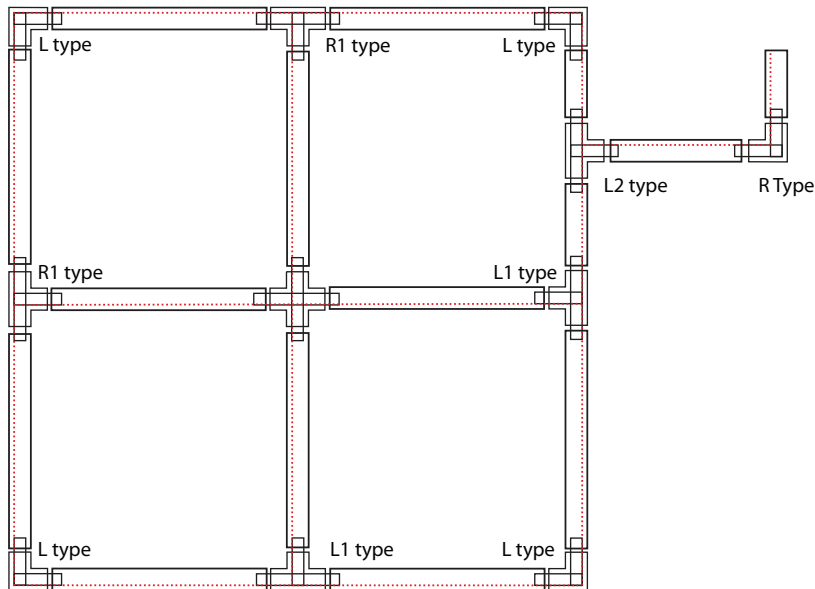

Product Code	Description
TRA3C-SJ	3 Circuit Track Adaptor - Straight Join
TRA3C-TL1	3 Circuit Track Adaptor - T Join (3 way) Type L1
TRA3C-TL2	3 Circuit Track Adaptor - T Join (3 way) Type L2
TRA3C-TR1	3 Circuit Track Adaptor - T Join (3 way) Type R1
TRA3C-TR2	3 Circuit Track Adaptor - T Join (3 way) Type R2
TRA3C-XJ	3 Circuit Track Adaptor - X Join (4 way)
TRA3C-R	3 Circuit Track Adaptor - Right Join
TRA3C-L	3 Circuit Track Adaptor - Left Join
TRA3C-RF	3 Circuit Track Adaptor - Flexible Right Join
TRA3C-LF	3 Circuit Track Adaptor - Flexible Left Join
TRA3C-DE	3 Circuit Track Adaptor - End Cap
TRA3C-LE	3 Circuit Track Adaptor - Power Connector







### Order Code

Trim Colour		
TRA3C-TL1	-	B
		W White Trim
		B Black Trim
		S Silver Trim

## SURFACE LED XSM

Surface mounted range of LED downlights available in 10W, 26W and 40W options using Japanese made COB LED's. Available in 3000K, 4000K and 5000K colour temperature options with a high CRI of 90+ across the range. Featuring integral drivers and pressure cast heatsink for continued high output and long lifespan.



-  LED: 10W
-  LED: 26W
-  LED: 40W
-  COB Lumens: 1390lm
-  COB Lumens: 2931lm
-  COB Lumens: 4000m
-  Lifespan: 50,000 hrs



### Technical Specifications

XSM10	3000K	4000K	5000K
COB Lumen Output	1335 lm	1390 lm	1410 lm
XSM26	3000K	4000K	5000K
COB Lumen Output	1954 lm	2041 lm	2063 lm
XSM40	3000K	4000K	5000K
COB Lumen Output	2344 lm	2931 lm	3077 lm
Lifetime	50,000hrs (L70)		
Power Factor	> 0.95		
Input Voltage	100V - 240V AC 50/60 Hz		
Protection	Thermal and Short Circuit		
Dimming	Leading / Trailing edge		Available on request DALI* 1-10v*

### Dimensions

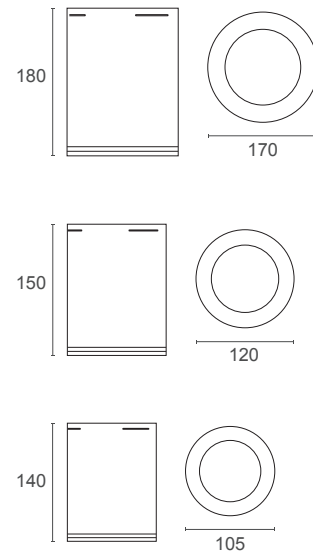

### Trim Colours

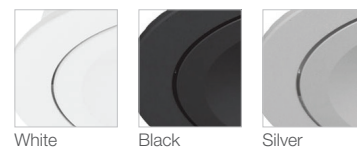

### Order Code

	Wattage	Colour Temperature	Beam Angle	Trim Colour	Dimming			
XSM	10	-	3	-	WB	-	B	Dim
	10 10W	3 3000K	WB Wide Beam	W White Trim	Dim Leading / Trailing			
	26 26W	4 4000K	NB Narrow Beam	B Black Trim	DALI DALI Dimming			
	40 40W	5 5000K		S Silver Trim	1-10 1-10v Dimming			



### WALLWASH LED XTW

Surface mounted wall washer with high output Japanese LEDs. High colour rendering index (CRI) of 83 and a high COB lumen output. Adjustable mounting brackets for various mounting positions. Manufactured from extruded aluminium with powdercoat finish and opaque acrylic diffuser for smooth beam distribution. Supplied with integral control gear with flex & plug.

- ⚡ LED: 25W / LCP: 28.1W
- ⚡ LED: 50W / LCP: 54W
- ☀️ COB Lumens: 2600lm
- ☀️ COB Lumens: 5200lm
- 🕒 Lifespan: 50,000 hrs



#### Technical Specifications

XTW25	3000K	4000K	5000K
COB Lumen Output	2400 lm	2600 lm	3000 lm
Lifetime	50,000hrs (L70)		
XTW50	3000K	4000K	5000K
COB Lumen Output	4800 lm	5200 lm	6000 lm
Lifetime	50,000hrs (L70)		
Power Factor	> 0.95		
Input Voltage	100V - 240V AC 50/60 Hz		
Protection	Thermal and Short Circuit		
Dimming	Leading / Trailing edge		Available on request DALI* 1-10V*

#### Dimensions

##### XTW25

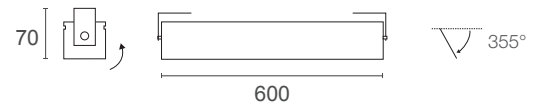

##### XTW50

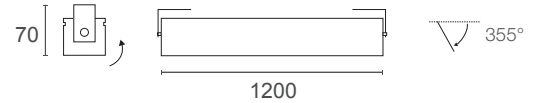

#### Trim Colours







#### Order Code

	Wattage	Colour Temperature	Beam Angle	Trim Colour	Dimming
XTW	25	-	3	-	WB
	25	25W (600mm)	3	3000K	WB Wide Beam
	50	50W (1200mm)	4	4000K	B Black Trim
			5	5000K	S Silver Trim
					Dim Leading / Trailing

## WALLWASH LED XWW

Recessed architectural wall washer using high output Japanese LEDs. High colour rendering index of 80 and high COB lumen outputs. Body Manufactured from powdercoated aluminium with opaque acrylic diffuser for smooth light distribution. Suitable for mounting in T-Bar ceilings or recessing into plaster ceilings.



-  LED: 25W / LCP: 28.1W
-  LED: 50W / LCP: 54W
-  COB Lumens: 2600lm
-  COB Lumens: 5200lm
-  Lifespan: 50,000 hrs



### Technical Specifications

XTW25	3000K	4000K	5000K
COB Lumen Output	2400 lm	2600 lm	3000 lm
Lifetime	50,000hrs (L70)		
XTW50	3000K	4000K	5000K
COB Lumen Output	4800 lm	5200 lm	6000 lm
Lifetime	50,000hrs (L70)		
Power Factor	> 0.95		
Input Voltage	100V - 240V AC 50/60 Hz		
Protection	Thermal and Short Circuit		
Dimming	Leading / Trailing edge		Available on request DALI* 1-10V*

### Dimensions

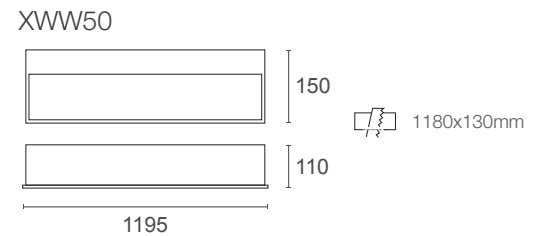
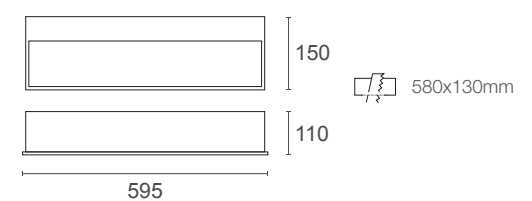

### Trim Colours

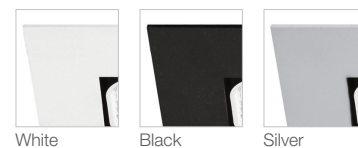

### Order Code

	Wattage	Colour Temperature	Beam Angle	Trim Colour	Dimming
XWW	25	-	3	-	WB
	25	25W (600mm)	3	3000K	WB Wide Beam
	50	50W (1200mm)	4	4000K	B Black Trim
			5	5000K	S Silver Trim
					Dim Leading / Trailing





### COVE LED XTP

Architectural surface mounted LED cove light featuring high output Japanese LED's. High COB lumen output of 1200Lm (3000K) and 1350Lm (4000K) for the 600mm XTP12 and 2400Lm (3000K) and 2700Lm (4000K) for the 1200mm XTP24. End-to-End linkable design allows for continuous light appearance and easy wiring. Manufactured from extruded aluminium with optional powdercoat finish and opaque acrylic diffuser for smooth light distribution. Supplied with integral control gear with flex & plug.

- ⚡ LED: 12W / LCP: 15W
- ⚡ LED: 24W / LCP: 48W
- ☀️ COB Lumens: 1350m
- ☀️ COB Lumens: 2700lm
- 🕒 Lifespan: 50,000 hrs



#### Technical Specifications

XTW25	3000K	4000K	5000K
COB Lumen Output	1200 lm	1350 lm	N/A
Lifetime	50,000hrs (L70)		
XTW50	3000K	4000K	5000K
COB Lumen Output	2400 lm	2700 lm	N/A
Lifetime	50,000hrs (L70)		
Power Factor	> 0.95		
Input Voltage	100V - 240V AC 50/60 Hz		
Protection	Thermal and Short Circuit		
Dimming	Leading / Trailing edge		Available on request DALI* 1-10V*

#### Dimensions

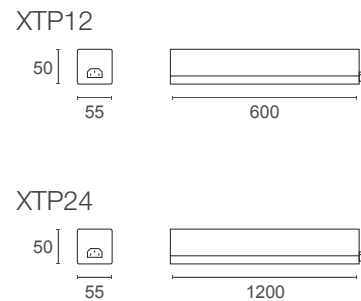

#### Trim Colours



#### Order Code

	Wattage	Colour Temperature	Beam Angle	Trim Colour	Dimming
XTW	25	-	3	-	WB
	12	12W (600mm)	3	3000K	WB Wide Beam
	24	24W (1200mm)	4	4000K	
				W	White Trim
				B	Black Trim
				S	Silver Trim
				Dim	Leading / Trailing

## FLEXILED XF1260

Flexible linear LED strip using high output Taiwanese made LED's. 'Peel off' 3M adhesive backing for easy, long term installation. Available in reels of up to 5 meters with cuttable intervals of 100mm.

- 12V DC LED Strip
- 60 LEDs per Meter
- 1000Lm per Meter
- Cuttable at 50mm increments (3 LEDs)
- Supplied with adhesive backing for quick application
- Supplied in 1M Increments, maximum continual length is 5m
- Available with optional extrusions profiles



- ⚡ LED: 15W/m (avg.)
- ☀️ COB Lumens: 1000Lm/m
- 🕒 Lifespan: 50,000 hrs



### Extrusion

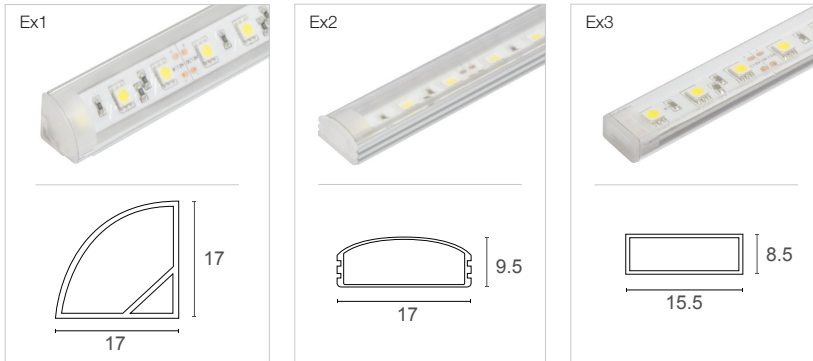

### Dimensions

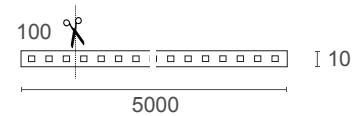

### Order Code

	Colour Temperature		Length (mm)		Extrusion
XF1260	3	-	1250	-	Ex1
	3 3000K		xx Max 5m (5000)		none No Extrusion
	4 4000K				Ex1 Corner Extrusion
	C RGB				Ex2 Flat Extrusion
					Ex3 Clear Extrusion





## FLEXILED LED DRIVER

	PS12015A	- 12V	1.5A	3m Maximum Strip Length
	PS12015A	- 12V	2.5A	3m Maximum Strip Length
	PS12015A	- 12V	5A	5m Maximum Strip Length
	PS12015A	- 12V	8A	10m Maximum Strip Length
	PS12015A	- 12V	12A	15m Maximum Strip Length
	PSRGB5A	- 12V	5A	LED RGB Controller (with remote)



### MAXIPENDANT XPL48

48 watt LED pendant with clear prismatic diffuser and cover lens, consisting of 8 Japanese made LED's in 3000K, 4000K and 5000K. All colour temperatures have a high colour rendering index (CRI) and high COB lumen outputs of 3840Lm (3000K), 4220Lm (4000K) and 4440Lm (5000K). Large passive heatsink provides effective thermal management ensuring high output and long lifespan. Supplied with remote driver and 2m MAX suspension cable.

-  LED: 48W / LCP: 54W
-  COB Lumens: 4420Lm/m
-  Lifespan: 50,000 hrs



#### Technical Specifications

	3000K	4000K	5000K
COB Lumen Output	3840 lm	4220 lm	4440 lm
Lifetime	50,000hrs (L70)		
Power Factor	> 0.95		
Input Voltage	100V - 240V AC 50/60 Hz		
Protection	Thermal and Short Circuit		
Dimming	Leading / Trailing edge		Available on request DALI* 1-10v*

#### Dimensions

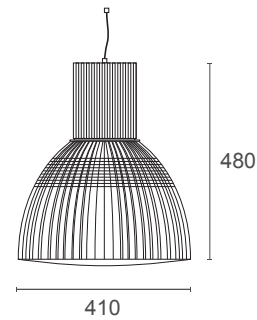

#### Trim Colours



Clear

#### Order Code

	Colour Temperature	Suspension Height
XPL48	3	- 800 mm
	3 3000K	xx mm Cable suspension height - max 3000mm
	4 4000K	
	5 5000K	

## MAXIPENDANT XPM

40W and 60W LED pendants consisting of 4 Japanese made LED's in 3000K, 4000K and 5000K. All colour temperatures have a high colour rendering index (CRI) and high COB lumen outputs . Spun aluminium reflector with floating frosted diffuser for uniform light distribution. Large passive heatsink provides effective thermal management ensuring high output and long lifespan. Supplied with remote driver and 2m MAX suspension cable.



- ⚡ LED: 43.2W / LCP: 46.7W
- ⚡ LED: 60W / LCP: 64.5W
- ☀️ COB Lumens: 5560lm
- ☀️ COB Lumens: 6620lm
- 🕒 Lifespan: 50,000 hrs



### Technical Specifications

XPM40	3000K	4000K	5000K
COB Lumen Output	5340 lm	5560 lm	5640 lm
Lifetime	50,000hrs (L70)		
XPM60	3000K	4000K	5000K
COB Lumen Output	6340 lm	6620 lm	6680 lm
Lifetime	50,000hrs (L70)		
Power Factor	> 0.95		
Input Voltage	100V - 240V AC 50/60 Hz		
Protection	Thermal and Short Circuit		
Dimming	Leading / Trailing edge		Available on request DALI* 1-10v*

### Dimensions

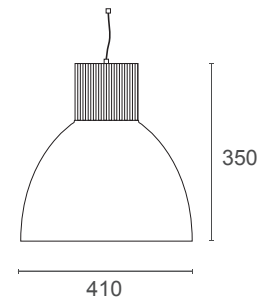

### Trim Colours



Aluminium



### Order Code

	Wattage		Colour Temperature		Suspension Height		
XPM	40	-	3	-	800 mm	-	DIM
	40 40W		3 3000K		xx mm	Cable suspension height - max 3000mm	Dim Leading / Trailing
	60 60W		4 4000K				DALI DALI Dimming
			5 5000K				1-10 1-10v Dimming



### MAXIPENDANT XPM

80 watt LED pendant consisting of a single Japanese made COB. High colour rendering index of 90+ and a high COB lumen output of 10850. Spun aluminium reflector with floating frosted diffuser for uniform light distribution. Large passive heatsink provides effective thermal management ensuring high output and long lifespan. Supplied with integral driver and 2m MAX suspension cable.

-  LED: 80W / LCP: 96W
-  COB Lumens: 10850lm
-  Lifespan: 50,000 hrs



#### Technical Specifications

	5000K
COB Lumen Output	10850 lm
Lifetime	50,000hrs (L70)
Power Factor	> 0.95
Input Voltage	100V - 240V AC 50/60 Hz
Protection	Thermal and Short Circuit

#### Dimensions

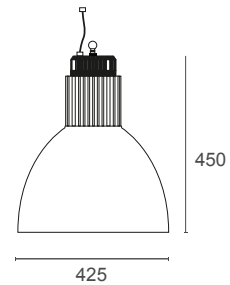

#### Trim Colours



Aluminium

#### Order Code

	Colour Temperature		Suspension Height
XPM80	5	-	800 mm
	5 5000K		xx mm Cable suspension height - max 3000mm